

2020  
0511

**Pineapple**



2020  
0511

PINEAPPLE

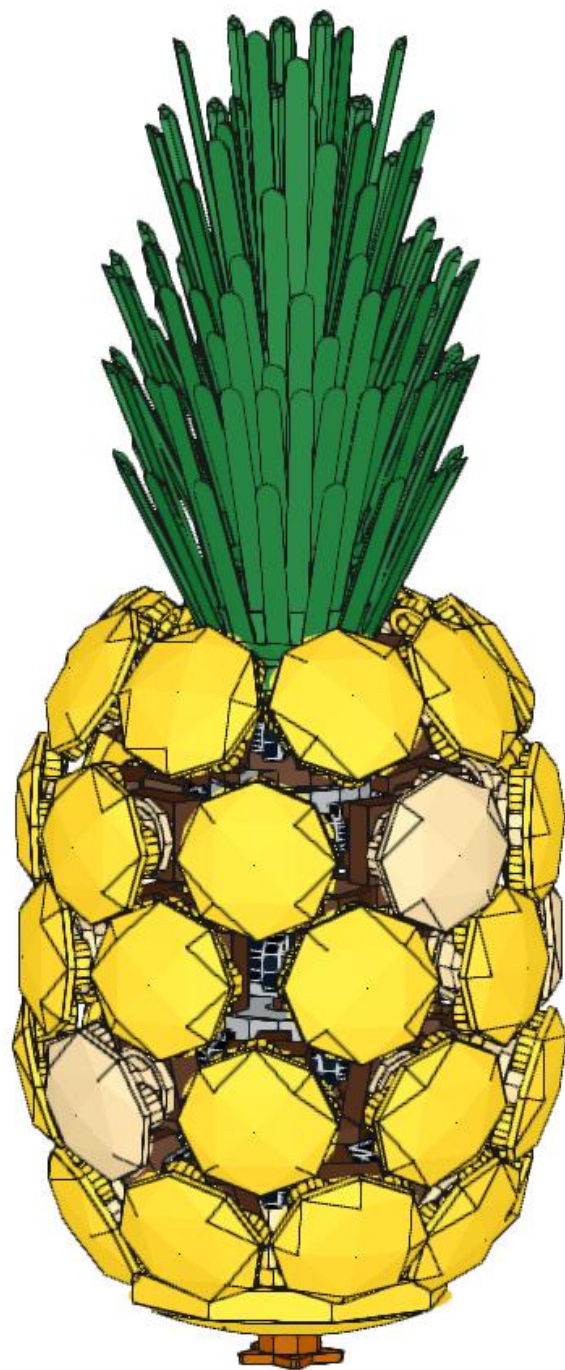

1

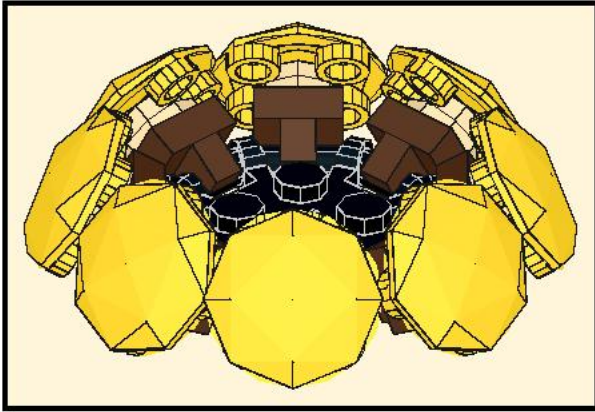

x2

2

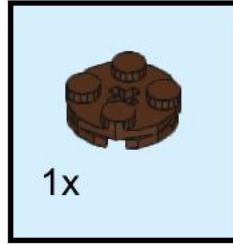

3

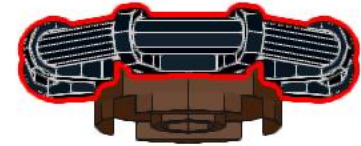
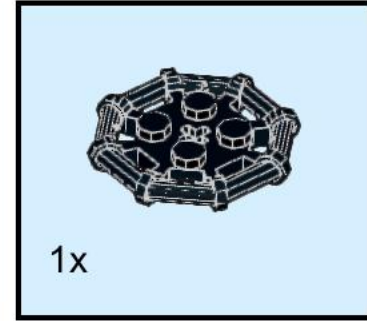

4

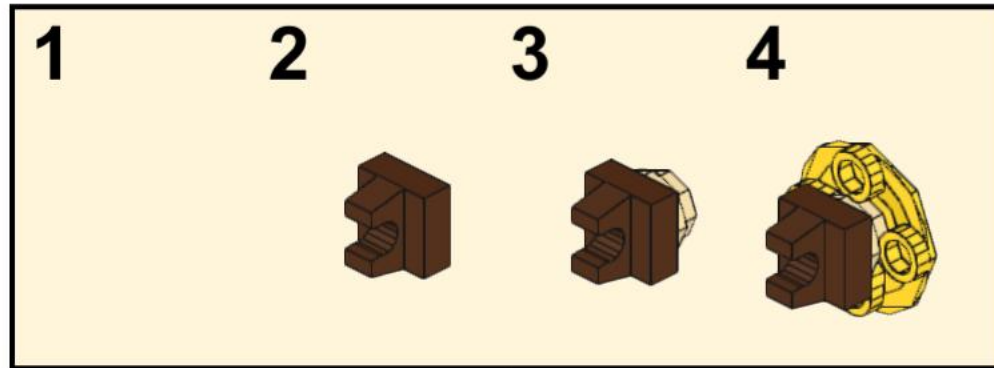
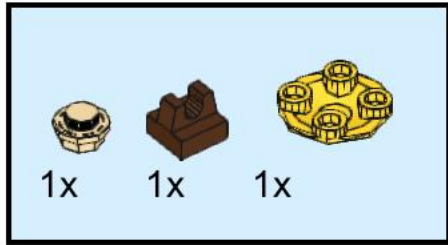

x8



5

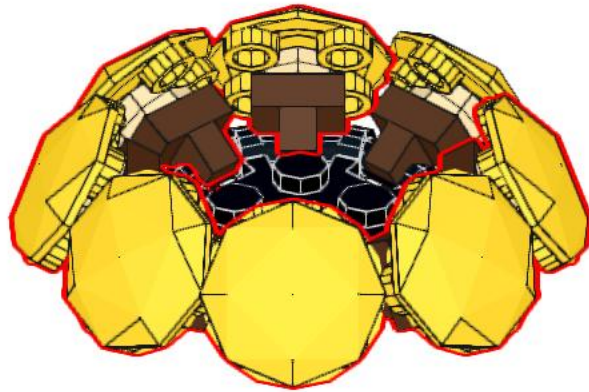
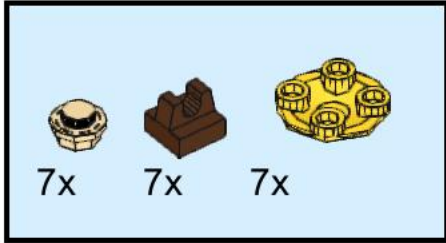



# 6

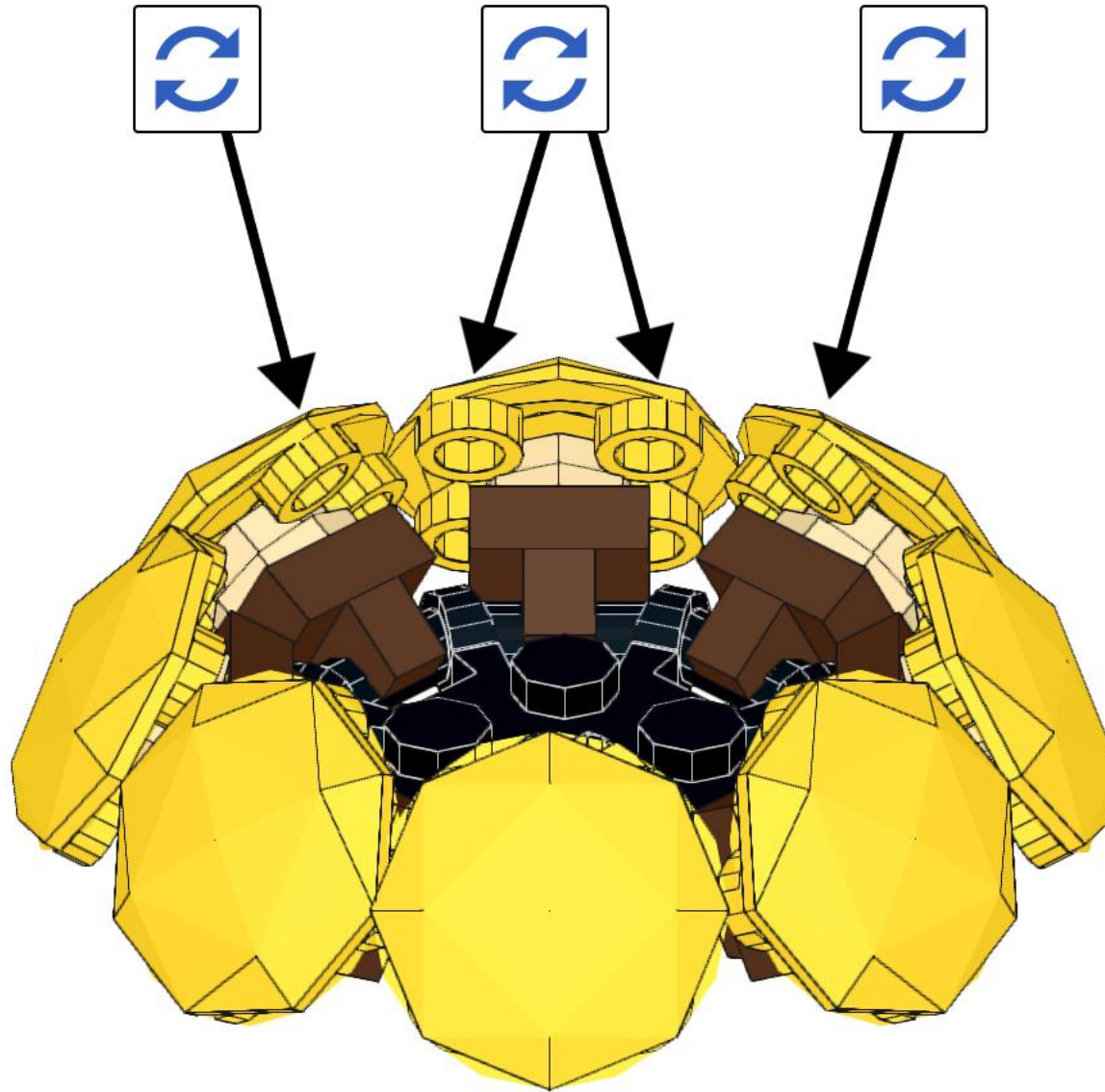

Rotate every other round plate, so that one stud points to the top. Alternate between, one pointing to the top, and two pointing to the top. Like this, the studs can interlock

7

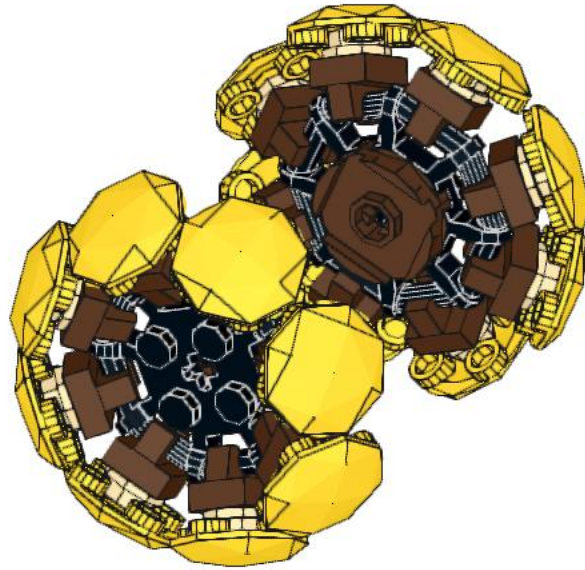
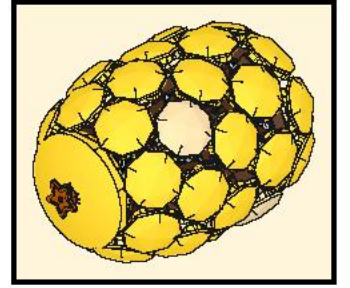

8

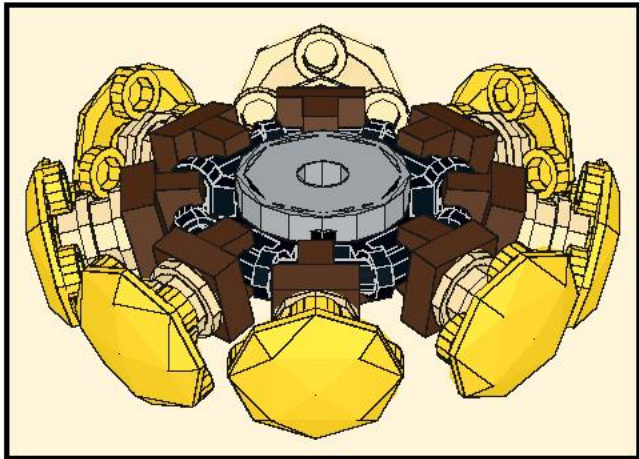

x3

9

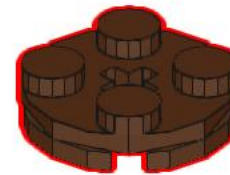



# 10

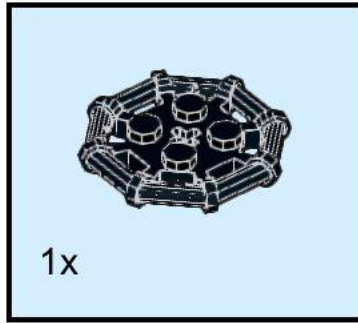

# 11

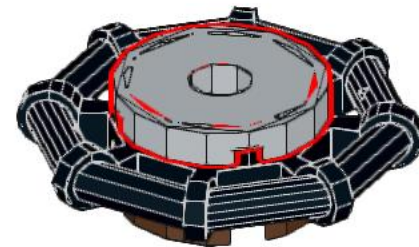
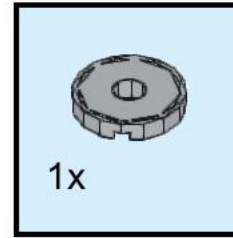

# 12

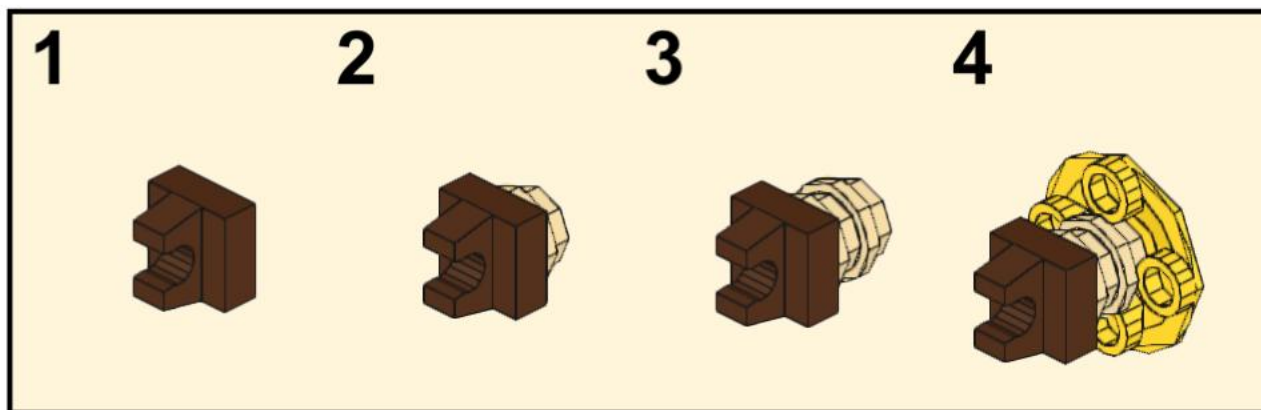
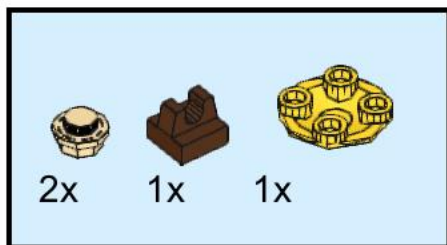

x8

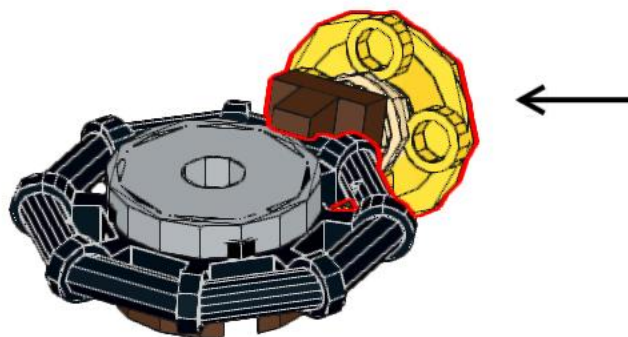

# 13

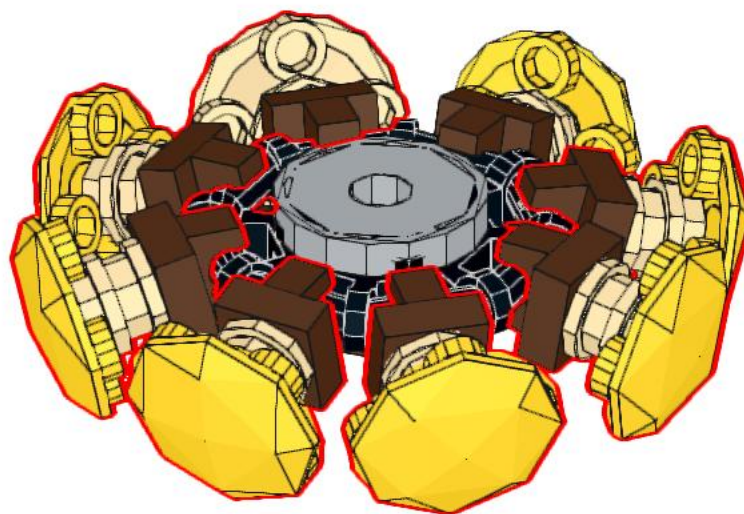
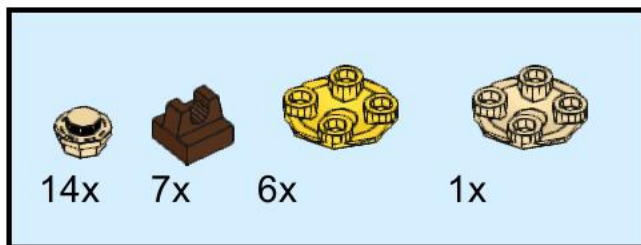

14

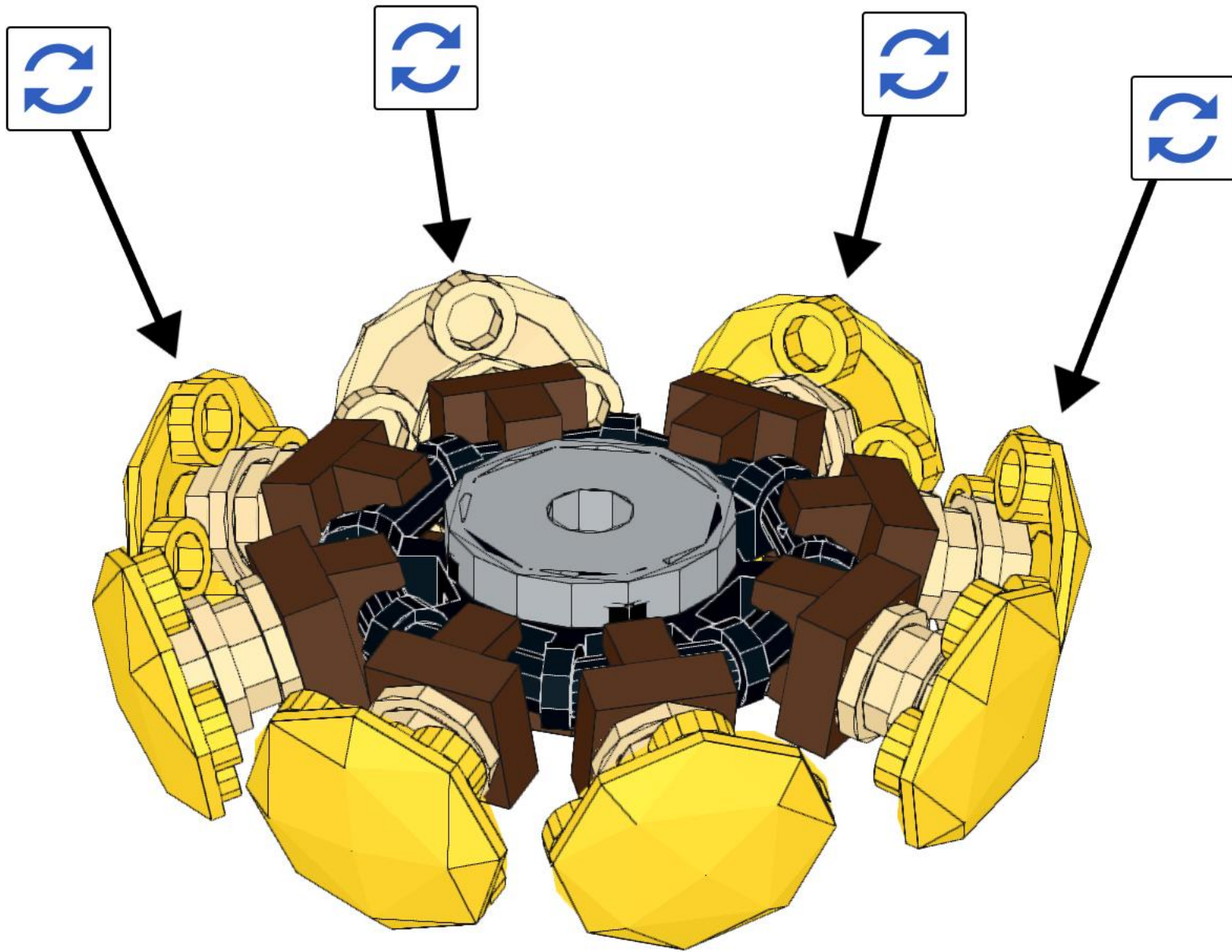

Rotate all round planes, so that always one stud points upwards.

# 15

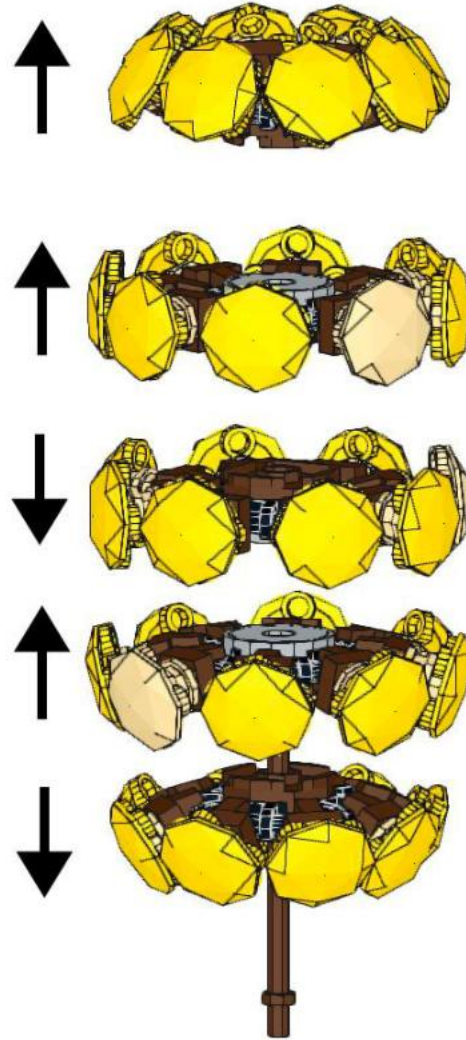



# 16

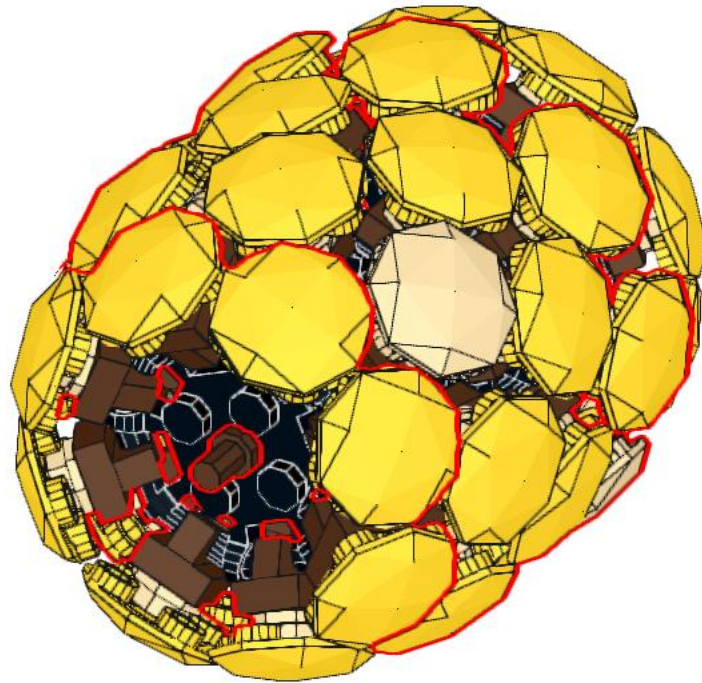
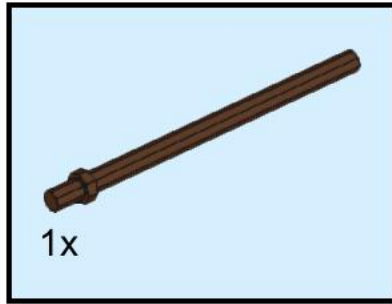

# 17

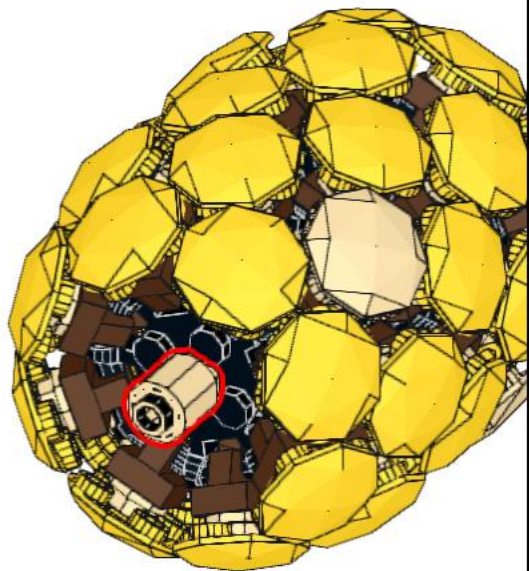
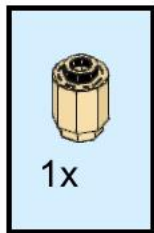

# 18

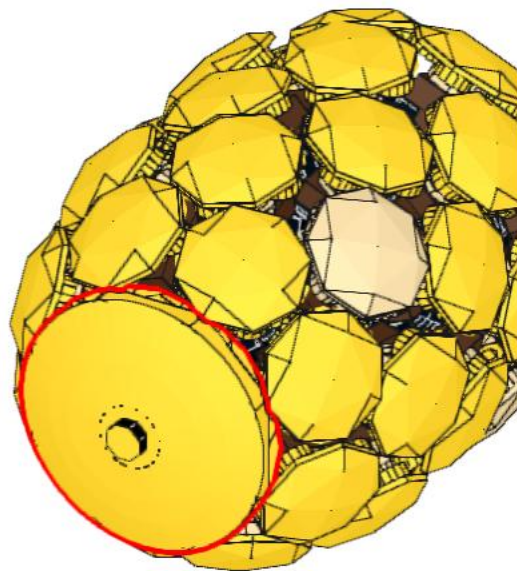
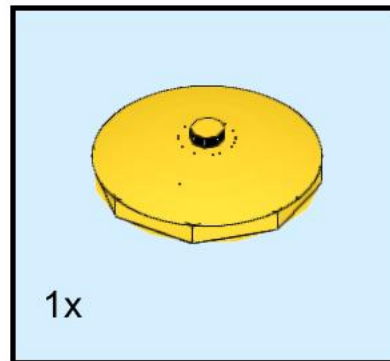

# 19

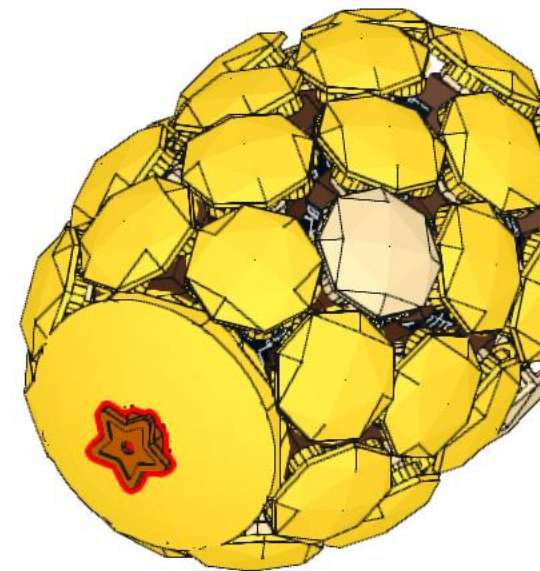

# 20

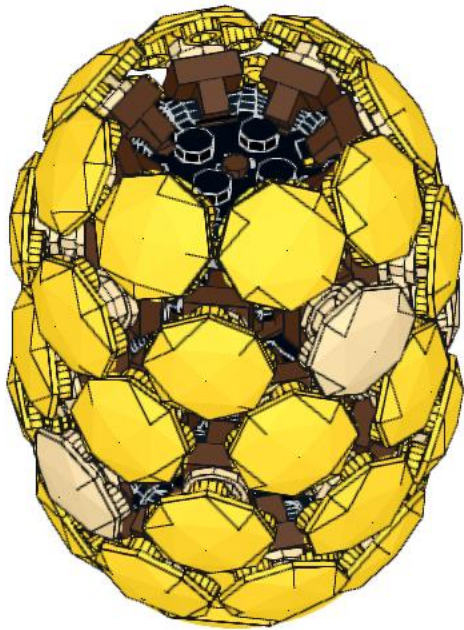

# 21

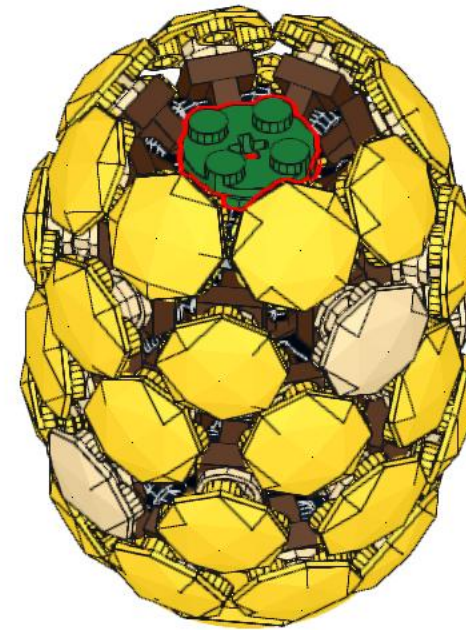
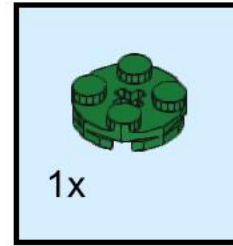

22

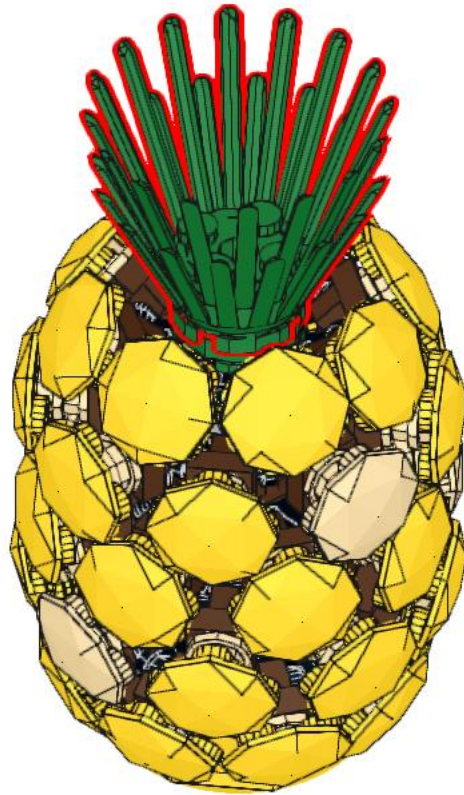
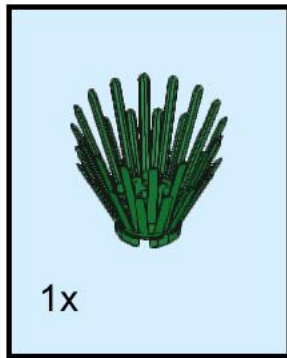



23

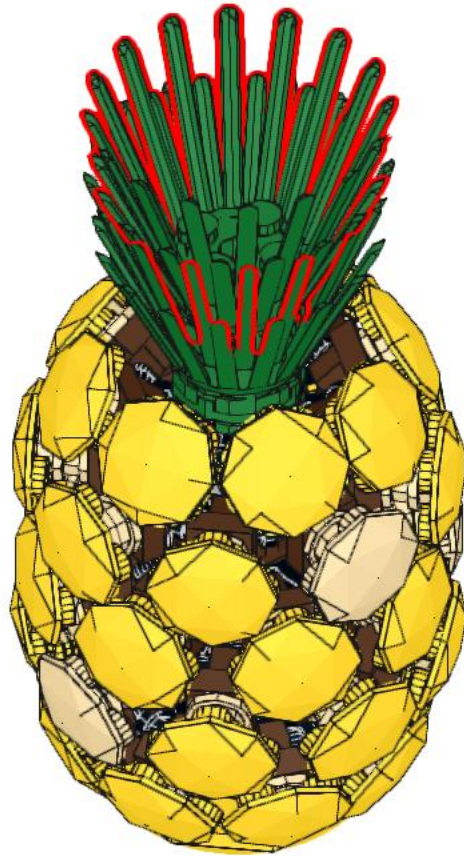
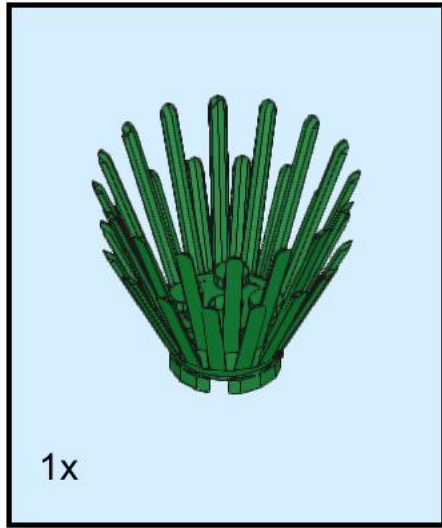



24

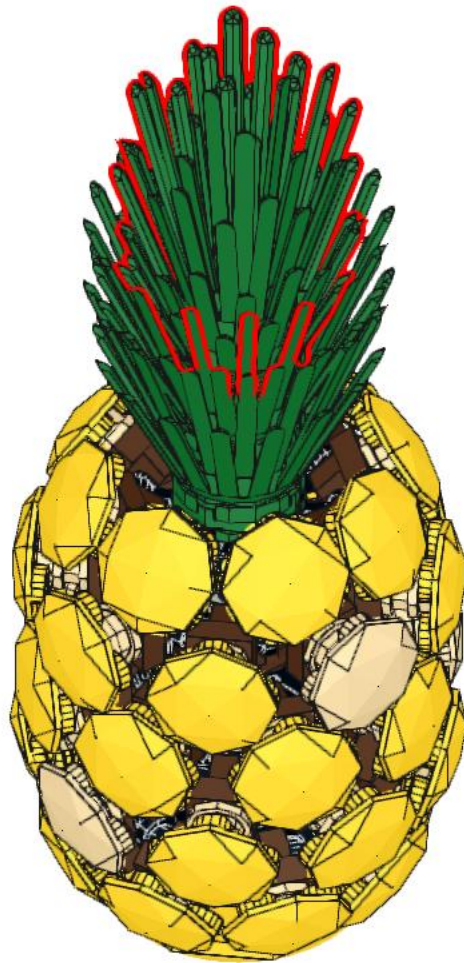
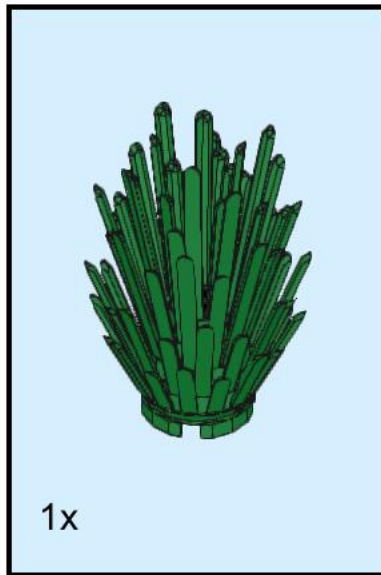

25

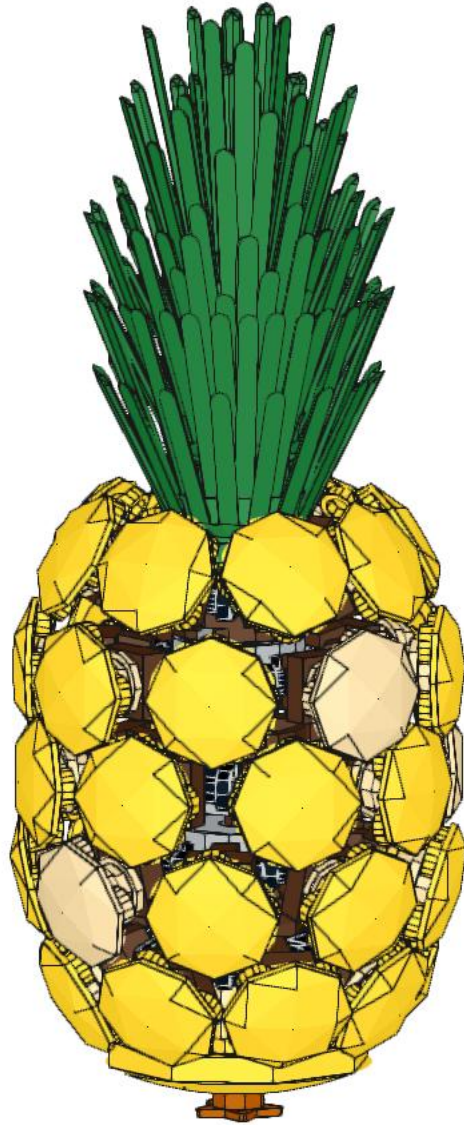

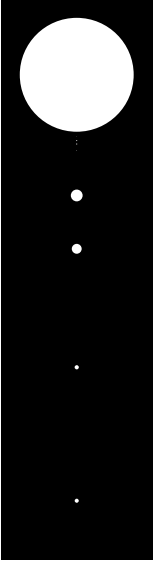

2020  
0511

# PARTS

# Pineapple

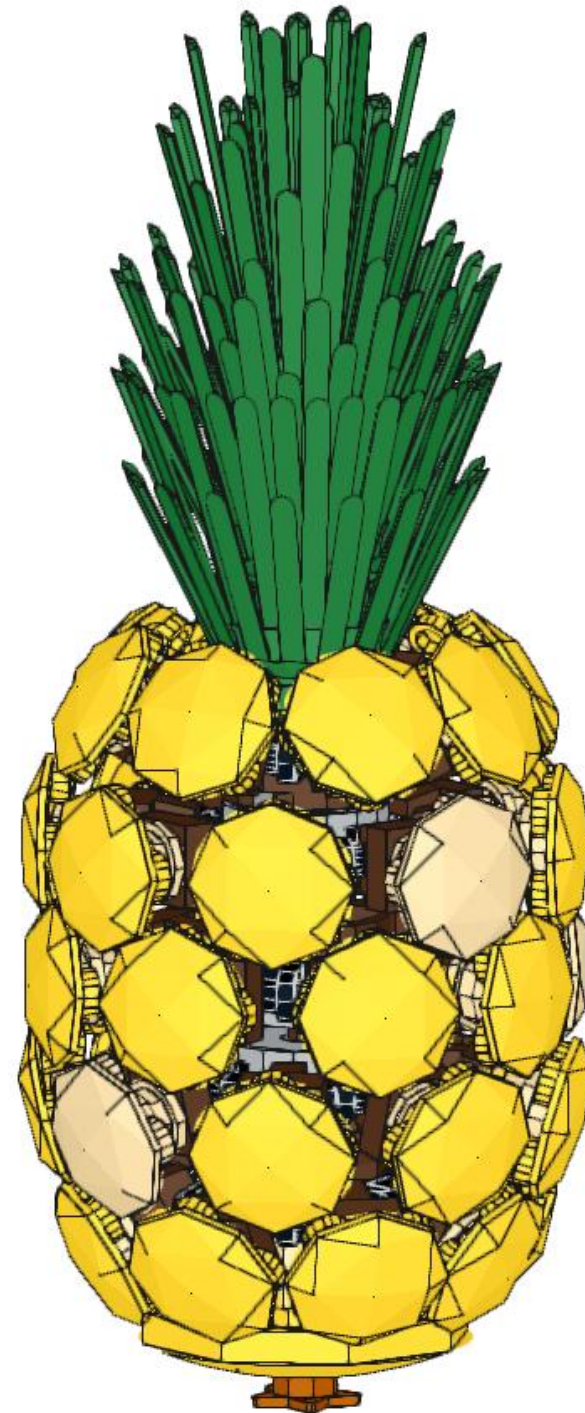



5x  
75937, 11

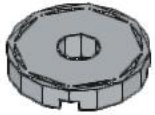

3x  
15535, 86



40x  
2555, 8



5x  
4032, 8



1x  
4095, 8



1x  
11609, 68



64x  
4073, 2



1x  
3062b, 2



3x  
2654, 2



37x  
2654, 3

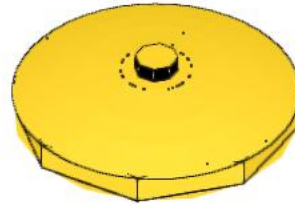

1x  
3960, 3



1x  
4032, 6

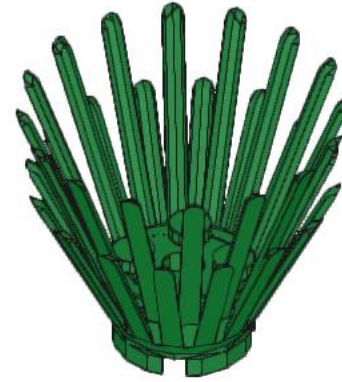

2x  
6065, 6

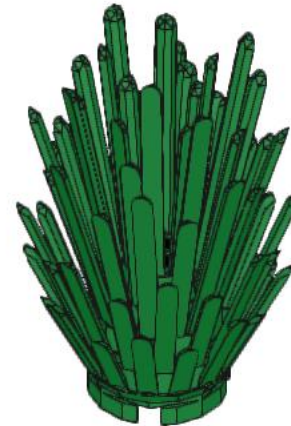

1x  
6064, 6

2020  
0511

ALTERNATIVE

**Pineapple**

